

BLADE® 200 SRX

#1 BY DESIGN



Instruction Manual
Bedienungsanleitung
Manuel d'utilisation
Manuale di Istruzioni



SAFE™

RTF
READY-TO-FLY



NOTICE

All instructions, warranties and other collateral documents are subject to change at the sole discretion of Horizon Hobby, LLC. For up-to-date product literature, visit horizonhobby.com and click on the support tab for this product.

Meaning of Special Language

The following terms are used throughout the product literature to indicate various levels of potential harm when operating this product:

NOTICE: Procedures, which if not properly followed, create a possibility of physical property damage AND a little or no possibility of injury.

CAUTION: Procedures, which if not properly followed, create the probability of physical property damage AND a possibility of serious injury.

WARNING: Procedures, which if not properly followed, create the probability of property damage, collateral damage, and serious injury OR create a high probability of superficial injury.

 **WARNING:** Read the ENTIRE instruction manual to become familiar with the features of the product before operating. Failure to operate the product correctly can result in damage to the product, personal property and cause serious injury.

This is a sophisticated hobby product. It must be operated with caution and common sense and requires some basic mechanical ability. Failure to operate this Product in a safe and responsible manner could result in injury or damage to the product or other property. This product is not intended for use by children without direct adult supervision. Do not use with incompatible components or alter this product in any way outside of the instructions provided by Horizon Hobby, LLC. This manual contains instructions for safety, operation and maintenance. It is essential to read and follow all the instructions and warnings in the manual, prior to assembly, setup or use, in order to operate correctly and avoid damage or serious injury.

Age Recommendation: Not for children under 14 years. This is not a toy.

Safety Precautions and Warnings

- Always keep a safe distance in all directions around your model to avoid collisions or injury. This model is controlled by a radio signal subject to interference from many sources outside your control. Interference can cause momentary loss of control.
- Always operate your model in open spaces away from full-size vehicles, traffic and people.
- Always carefully follow the directions and warnings for this and any optional support equipment (chargers, rechargeable battery packs, etc.).
- Always keep all chemicals, small parts and anything electrical out of the reach of children.
- Always avoid water exposure to all equipment not specifically designed and protected for this purpose. Moisture causes damage to electronics.
- Never place any portion of the model in your mouth as it could cause serious injury or even death.
- Never operate your model with low transmitter batteries.
- Always keep aircraft in sight and under control.
- Always move the throttle fully down at rotor strike.
- Always use fully charged batteries.
- Always keep transmitter powered on while aircraft is powered.
- Always remove batteries before disassembly.
- Always keep moving parts clean.
- Always keep parts dry.
- Always let parts cool after use before touching.
- Always remove batteries after use.
- Never operate aircraft with damaged wiring.
- Never touch moving parts.

 **WARNING AGAINST COUNTERFEIT PRODUCTS:** If you ever need to replace your Spektrum receiver found in a Horizon Hobby product, always purchase from Horizon Hobby, LLC or a Horizon Hobby authorized dealer to ensure authentic high-quality Spektrum product. Horizon Hobby, LLC disclaims all support and warranty with regards, but not limited to, compatibility and performance of counterfeit products or products claiming compatibility with DSM or Spektrum.

Table of Contents

First Flight Preparation.....	4	Control Tests.....	10
Flying Checklist.....	4	Understanding the Primary Flight Controls.....	11
Charging Warnings.....	4	Flying the 200 SR X.....	12
Battery Charging.....	5	Post-Flight Inspection and Maintenance Checklist.....	12
Installing the Transmitter Batteries (RTF).....	5	Troubleshooting Guide.....	13
Transmitter Setup Table.....	6	Exploded View.....	14
Installing the Flight Battery.....	7	Parts Listings.....	14
Transmitter and Receiver Binding.....	7	Limited Warranty.....	15
SAFE Technology.....	8	Warranty and Service Contact Information.....	16
Panic Recovery.....	8	FCC Information.....	16
Transmitter Control.....	9	IC Information.....	16
Flight Mode and Rate Selection.....	9	Compliance Information for the European Union.....	17

Features	RTF	BNF
Airframe – Blade® 200 SR X	Included	Included
Main Motor - 3900Kv Brushless	Installed	Installed
Tail Motor - 5100Kv Brushless	Installed	Installed
Receiver - Spektrum™ AR636H Receiver	Installed	Installed
ESC - Dual Brushless ESC	Installed	Installed
Battery – 800mAh 3S 11.1V 30C Li-Po	Included	Included
Charger – 3S 0.8A Li-Po Balancing Charger with AC to DC Adapter	Included	Included
Transmitter – LP6DSM SAFE™ Transmitter	Included	Required

Specifications			
Length	14.76 in (375mm)	Tail Rotor Diameter	3.25 in (82.5mm)
Height	5.31 in (135mm)	Flying Weight	8.82 oz (250 g)
Main Rotor Diameter	16.14 in (410mm)	<i>To register your product online, visit www.bladehelis.com</i>	

Box Contents

- Blade 200 SR X
- 800mAh 3S 11.1V 30C Li-Po Battery
- 3S Li-Po Balancing Charger with AC to DC Adapter
- LP6DSM SAFE Transmitter (RTF Only)
- 4 AA Batteries (RTF Only)

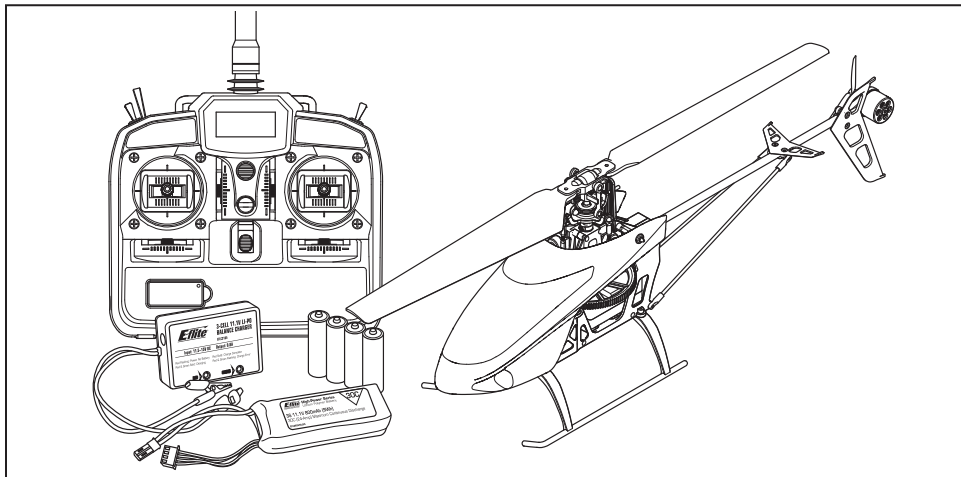

First Flight Preparation

- Remove and inspect contents
- Begin charging the flight battery
- Install the flight battery in the helicopter (once it has been fully charged)
- Program your computer transmitter (BNF only)
- Bind your transmitter (BNF only)
- Familiarize yourself with the controls
- Find a suitable area for flying

Charging Warnings

The battery charger (EFLC3105) included with your helicopter has been designed to safely charge the Li-Po battery.



CAUTION: All instructions and warnings must be followed exactly. Mishandling of Li-Po batteries can result in a fire, personal injury and/or property damage.

- By handling, charging or using the included Li-Po battery, you assume all risks associated with lithium batteries.
- If at any time the battery begins to balloon or swell, discontinue use immediately. If charging or discharging, discontinue and disconnect. Continuing to use, charge or discharge a battery that is ballooning or swelling can result in fire.
- Always store the battery at room temperature in a dry area for best results.
- Always transport or temporarily store the battery in a temperature range of 40–120° F (5–49° C). Do not store the battery or model in a car or direct sunlight. If stored in a hot car, the battery can be damaged or even catch fire.

Flying Checklist

- Always turn the transmitter on first**
- Plug the flight battery into the lead from the ESC
- Allow the receiver and ESC to initialize and arm properly
- Fly the model
- Land the model
- Unplug the flight battery from the ESC
- Always turn the transmitter off last**

- Always charge batteries away from flammable materials.
- Always inspect the battery before charging.
- Always disconnect the battery after charging, and let the charger cool between charges.
- Always constantly monitor the temperature of the battery pack while charging.
- **ONLY USE A CHARGER SPECIFICALLY DESIGNED TO CHARGE LI-PO BATTERIES.** Failure to charge the battery with a compatible charger may cause a fire resulting in personal injury and/or property damage.
- Never discharge Li-Po cells to below 3V under load.
- Never cover warning labels with hook and loop strips.
- Never leave charging batteries unattended.
- Never charge batteries outside recommended levels.
- Never charge damaged batteries.
- Never attempt to dismantle or alter the charger.
- Never allow minors to charge battery packs.
- Never charge batteries in extremely hot or cold places (recommended between 40–120° F or 5–49° C) or place in direct sunlight.

Battery Charging

NOTICE: Charge only batteries that are cool to the touch and are not damaged. Look at the battery to make sure it is not damaged e.g., swollen, bent, broken or punctured.

1. Connect the AC to DC adapter to an AC outlet.
2. Connect the AC to DC adapter to the charger.
3. Connect the battery balance lead to the charger.
The connector is keyed to prevent reverse polarity connection.
4. Always disconnect the flight battery from the charger immediately upon completion of charging.

LED Indicators

Red Flashing LED: Input power with no battery connected

Red and Green Solid LEDs: Battery connected and charging

Red Solid LED: Charge complete

Red and Green Flashing LEDs: Charge error

Charging a fully discharged (not over-discharged) 800mAh battery takes approximately 1–1.5 hours.

The charger can also be powered through the DC alligator clips. Connect them to a 11.5–15V DC power source, noting proper polarity.



CAUTION: Do not connect to AC and DC power sources at the same time. Doing so may cause a short circuit, resulting in damage to the product, personal injury or property damage.

NOTICE: Always connect cable polarities correctly. Consult the battery instructions, safety sheet or product support before using a 12V battery with sources other than a standard AC wall outlet.

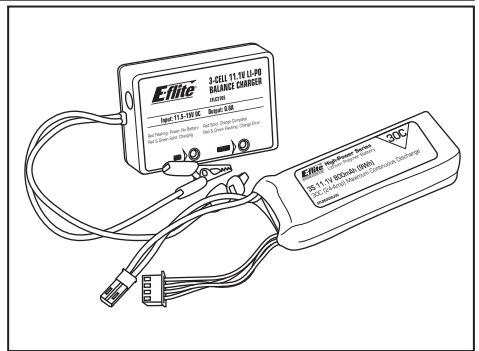

Installing the Transmitter Batteries (RTF)

Replace the transmitter batteries when the transmitter beeps.

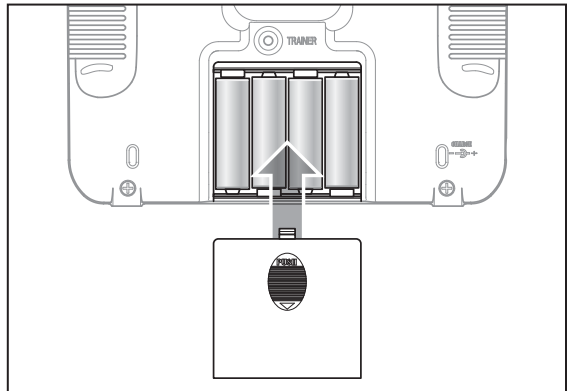

Transmitter Setup Table

Transmitter	Model Type	Setup / Channel Assignments		Reversing Setup	Flight Modes			Dual Rates	High Rate	Low Rate	Other Settings
		DIP Switches: 1, 2, 4, 5, 6, 7, 9, and 10 = OFF 3 and 8 = ON	N/A		CH 5 Pos 0 = Beginner CH 5 Pos 1 = Intermediate CH 5 Pos 2 = Experienced	CH 5 Pos 0 = Beginner CH 5 Pos 1 = Intermediate CH 5 Pos 2 = Experienced	CH 5 Pos 0 = Beginner CH 5 Pos 1 = Intermediate CH 5 Pos 2 = Experienced				
MLP6DSM	N/A		N/A		CH 5 Pos 0 = Beginner CH 5 Pos 1 = Intermediate CH 5 Pos 2 = Experienced	Default	100% Fixed	70% Fixed			
DX4e (New) w/ 3 Position Switch	N/A	MIX=NOR	All channels = NORM		CH 5 Pos 0 = Beginner CH 5 Pos 1 = Intermediate CH 5 Pos 2 = Experienced	Ail/Ele/Rud	100% Fixed	70% Fixed			
DX5e (New) w/ 3 Position Switch	N/A	MIX=NOR	All channels = NORM		CH 5 Pos 0 = Beginner CH 5 Pos 1 = Intermediate CH 5 Pos 2 = Experienced	Ail/Ele/Rud	100% Fixed	70% Fixed			
DX7/7SE	Acro	Gear=INH Flap=GEAR Trainer=Aux1	AUX1 = REV Throttle Travel = 85% Low, 100% Full	Gyro Switch Pos 0 = Beginner			100% Fixed	70%	Timer Count Down 08:00 Tone Start: Throttle Out Pos: 25%		
				Gyro Switch Pos 1 = Intermediate							
				Gyro Switch Pos 2 = Experienced							
DX8	Acro	Flap=INH Trainer=AUX1 Gear=INH F Mode=Gear	AUX1 = REV All Others = NORM Throttle Travel = 85% Low, 100% Full	Switch B Pos 0 = Beginner			100% Fixed	70%	Timer Count Down 08:00 Tone Start: Throttle Out Pos: 25%		
				Switch B Pos 1 = Intermediate							
				Switch B Pos 2 = Experienced							
DX9/DX18	Acro	Channel Input Config 5 GEAR = B 6 AUX 1 = 1	AUX1 =REV Throttle Travel = 85% Low, 100% Full	Switch B Pos 0 = Beginner			100% Fixed	70%	Timer Count Down 08:00 Tone Start: Throttle Out		
				Switch B Pos 1 = Intermediate							
				Switch B Pos 2 = Experienced							

Installing the Flight Battery

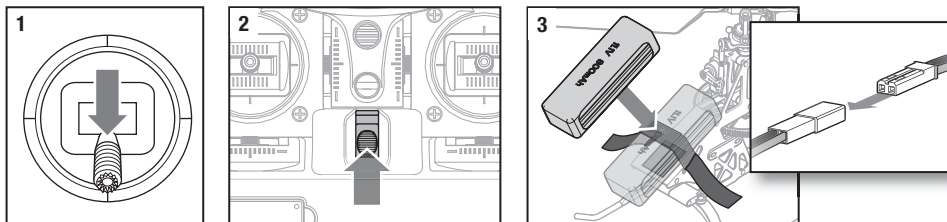

1. Lower the throttle stick to the lowest position. If your transmitter utilizes mechanical trims (like the included RTF transmitter), set the throttle trim to the highest position. Set all other trims to the center position.
2. Power ON the transmitter.
3. Attach the hook material to the helicopter frame and the loop material to the flight battery.
4. Install the flight battery on the helicopter frame. Secure the flight battery with the hook and loop strap.
5. Connect the battery connector to the ESC.
6. Place the helicopter on a flat surface and leave it still until the ESC beeps twice and the blue LED glows solid, indicating initialization is complete.

If you experience issues during initialization, refer to the Troubleshooting Guide at the back of the manual.

CAUTION: Always disconnect the Li-Po battery from the aircraft when not flying to avoid over-discharging the battery. Batteries discharged to a voltage lower than the lowest approved voltage may become damaged, resulting in loss of performance and potential fire when batteries are charged.

Transmitter and Receiver Binding



To bind or re-bind your helicopter to your chosen transmitter, please follow the directions below.

General Binding Procedure

1. Disconnect the flight battery from the helicopter.
2. Refer the Transmitter Setup Table to correctly setup your transmitter.
3. Lower the throttle stick to the lowest position. If your transmitter utilizes mechanical trims (like the included RTF transmitter), set the throttle trim to the highest position. Set all other trims to the center position.
4. Power off the transmitter and move all switches to the 0 position. Move the throttle to the low/off position.
5. Install the bind plug in the receiver BIND/PROG port.
6. Connect the flight battery to the ESC. The receiver LED flashes, indicating it is in bind mode.
7. Put the transmitter into bind mode while powering on the transmitter.
8. Release the bind button/switch after 2–3 seconds. The helicopter is bound when the LED on the receiver turns solid.
9. Disconnect the flight battery and power the transmitter off.

CAUTION: When using a Futaba® transmitter with a Spektrum™ DSM2®/DSMX® module, you must reverse the throttle channel and re-bind. Refer to your Spektrum module manual for binding and failsafe instructions. Refer to your Futaba transmitter manual for instructions on reversing the throttle channel.

Your RTF transmitter comes prebound to the model. If you need to re-bind, follow the directions below.

LP6DSM Binding Procedure

1. Disconnect the flight battery from the helicopter.
2. Lower the throttle stick to the lowest position. Set the throttle trim to the highest position. Set all other trims to the center position.
3. Power off the transmitter.
4. Install the bind plug in the receiver BIND/PROG port.
5. Connect the flight battery to the ESC. The receiver LED flashes, indicating it is in bind mode.
6. When the LED is flashing, press and hold the Bind Switch while powering on the transmitter.
7. The transmitter will beep and the LED will blink. Release the Bind Switch when the transmitter stops beeping.
8. The helicopter is bound when the LED on the receiver control unit is solid.
9. Disconnect the flight battery and power the transmitter off.

If you encounter problems, obey binding instructions and refer to the troubleshooting guide for other instructions. If needed, contact the appropriate Horizon Product Support office. For a list of compatible DSM® transmitters, please visit www.bindnfly.com.



SAFE™ Technology

Revolutionary SAFE™ (Sensor Assisted Flight Envelope) technology uses an innovative combination of multi-axis sensors and software that allows model aircraft to know its position relative to the horizon. This spatial awareness is utilized to create a controlled flight envelope the aircraft can use to maintain a safe region of bank and pitch angles so you can fly more safely. Far beyond stability, this level of protection offers multiple modes so the pilot can choose to develop his or her skills with a greater degree of security and flight control that always feels crisp and responsive.

SAFE technology delivers:

- Flight envelope protection you can enable at the flip of a switch.
- Multiple modes let you adapt SAFE technology to your skill level instantly.

Best of all, sophisticated SAFE technology doesn't require any work to enjoy. Every aircraft with SAFE installed is ready to use and optimized to offer the best possible flight experience.

FlySAFERC.com

Panic Recovery

- Immediate recovery to a safe flying attitude.
- Move the throttle to 50% and return all other transmitter controls to neutral for the quickest recovery.
- This mode is intended to provide the pilot with the confidence to continue to improve their flight skills.

If you get into distress while flying in any mode, pull and hold the Bind/Panic Switch and move the control sticks to their neutral position. The SAFE technology will return the aircraft to a stable attitude, if the aircraft is at a sufficient height with no obstacles in its path. Release the Panic Switch to turn off Panic Recovery and return to the current flight mode.

Transmitter Control

RTF

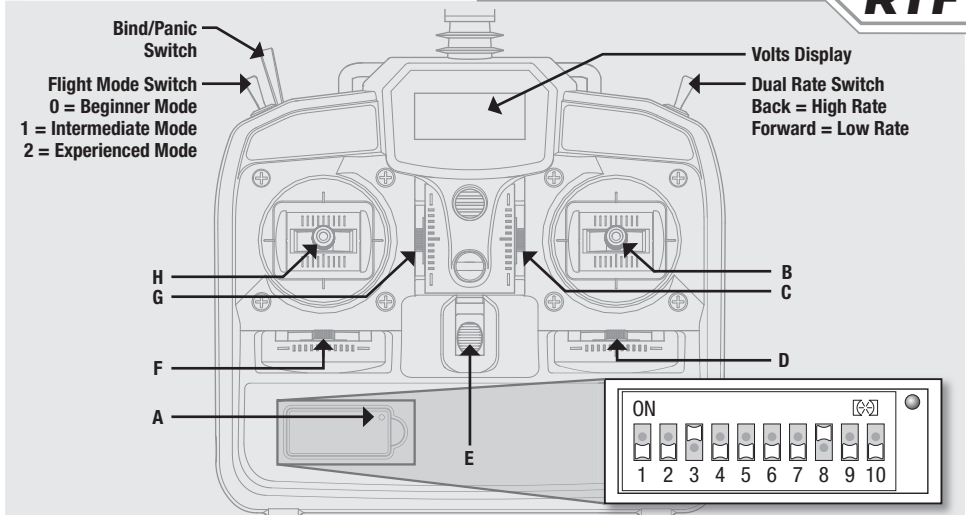

	A	B	C	D	E	F	G	H
Mode 1	Power LED	Aileron (Left/Right) Throttle (Up/Down)	Throttle Trim	Aileron Trim	ON/OFF Switch	Rudder Trim	Elevator Trim	Rudder (Left/Right) Elevator (Up/Down)
Mode 2	Power LED	Aileron (Left/Right) Elevator (Up/Down)	Elevator Trim	Aileron Trim	ON/OFF Switch	Rudder Trim	Throttle Trim	Rudder (Left/Right) Throttle (Up/Down)

Flight Mode and Rate Selection

Refer to the *Transmitter Setup Table* for which switch on your transmitter selects flight modes and specific setup information.

RTF

Change flight modes by moving the three-position flight mode switch. Ensure the flight mode switch is in the desired position before flying.

- In Beginner Mode (switch position 0), the bank angle is limited to 15 degrees. When the cyclic stick is released, the model will return to level.
- In Intermediate Mode (switch position 1), the bank angle is limited to 35 degrees. When the cyclic stick is released, the model will return to level.
- In Experienced Mode (switch position 2), the bank angle is not limited. When the sticks are released, the model will not return to level. If you lose orientation, use the Panic Switch to return the model to a familiar orientation.

Change rates by moving the two-position dual rate switch.

- Low rate reduces the control rates, providing an easier to fly model. Beginners should use low rate for initial flights.
- High rate provides full control and should be used by intermediate and experience pilots.

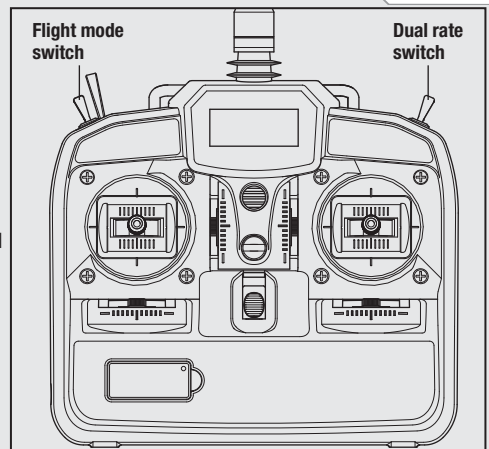

Control Tests

Test the controls prior to the first flight to ensure the servos, linkages and parts operate correctly. Ensure the throttle is in the low position when doing the control tests.

Elevator

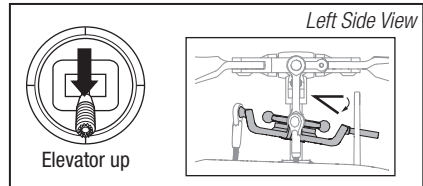
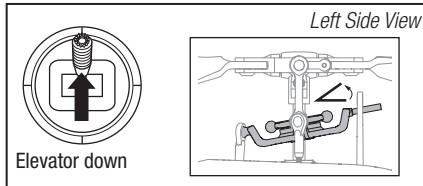

Aileron

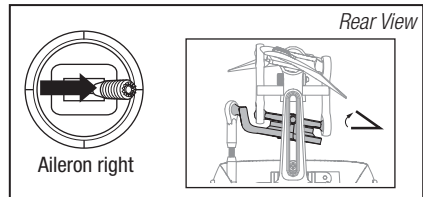
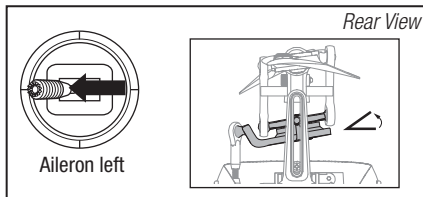

Motor

Place the helicopter outdoors on a clean, flat and level surface (concrete or asphalt) free of obstructions. Always stay clear of moving rotor blades.



CAUTION: Keep pets and other animals away from the helicopter. Animals may injure themselves if they attack or run toward the helicopter.

1. The motor beeps twice when the helicopter's ESC arms properly. Before you continue, confirm that throttle is at full low position.



WARNING: Stay at least 30 feet (10 meters) away from the helicopter when the motor is running. Do not attempt to fly the helicopter at this time.

2. Ensure the throttle is lowered completely. Ensure the transmitter is still setup as described in the Transmitter Setup Table. Slowly increase the throttle until the blades begin to spin. The main blades spin clockwise when viewing the helicopter from the top. The tail rotor blades spin counterclockwise when viewing the helicopter from the right-hand side.

NOTICE: If the main rotor blades are spinning counterclockwise, reduce the throttle to low immediately. Disconnect the battery from the helicopter and reverse any two motor wire connections to the ESC and repeat the motor control test.

Understanding the Primary Flight Controls

If you are not familiar with the controls of your 200 SR X, take a few minutes to familiarize yourself with them before attempting your first flight.

Throttle

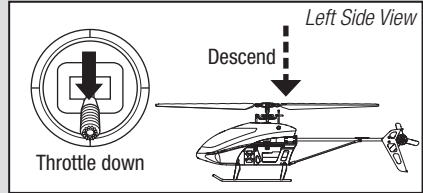
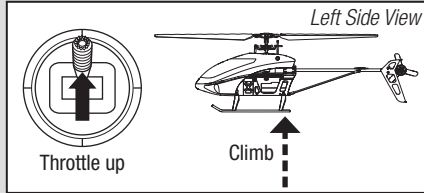

Rudder

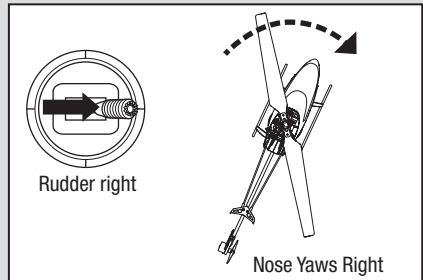
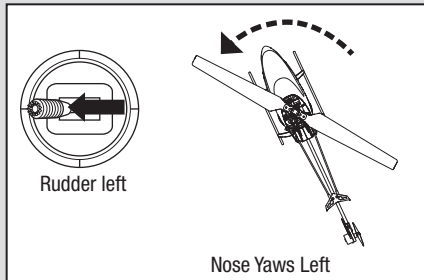

Elevator

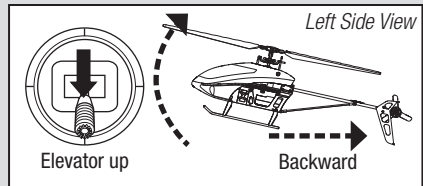
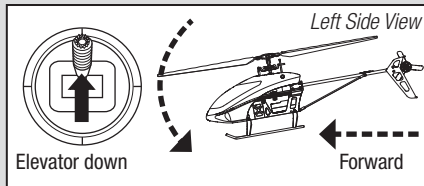

Aileron

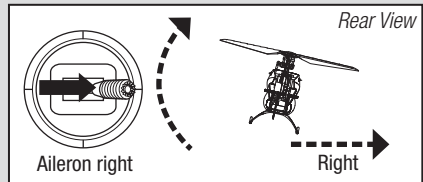
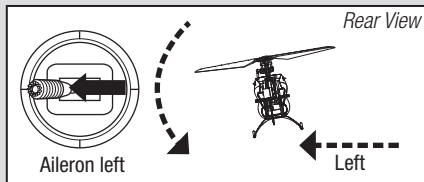

Flying the 200 SR X

Consult your local laws and ordinances before choosing a location to fly your aircraft.

We recommend flying your aircraft outside in calm winds (3 MPH or less) or inside a large gymnasium. Always avoid flying near houses, trees, wires and buildings. You should also be careful to avoid flying in areas where there are many people, such as busy parks, schoolyards or soccer fields.

It is best to fly from a smooth flat surface as this will allow the model to slide without tipping over. Keep the helicopter approximately 2 ft (600mm) above the ground. Keep the tail pointed toward you during initial flights to keep the control orientation consistent. Releasing the stick in Beginner or Intermediate Modes will allow the helicopter to level itself and activating the Panic Switch will level the helicopter quickly. If you become disoriented, slowly lower the throttle stick to land softly. During initial flights, only attempt hovering the model in one spot and takeoff and landing.

Flying the 200 SR X continued

Takeoff

Place the model onto a flat, level surface free of obstacles and walk back 30 feet (10 meters). Slowly increase the throttle until the model is approximately 2 ft. (600mm) off the ground and check the trim so the model flies as desired. Once the trim is adjusted, begin flying the model.

Typical flight time for the included battery is approximately 10 minutes.

Hovering

Making small corrections on the transmitter, try to hold the helicopter in one spot. If flying in calm winds, the model should require almost no corrective inputs. After moving the cyclic stick and returning it to center the model should level itself. The model may continue to move due to inertia. Move the cycle stick in the opposite direction to stop the movement.

After you become comfortable hovering, you can progress into flying the model to different locations, keeping the tail pointed towards you at all times. You can also ascend and descend using the throttle stick. Once you're comfortable with these maneuvers, you can attempt flying with the tail in different orientations. It is important to keep in mind that the flight control inputs will rotate with the helicopter, so always try to picture the control inputs relative to the nose of the helicopter. For example, forward will always drop the nose of the helicopter.

Low Voltage Cutoff (LVC)

LVC decreases the power to the motors when the battery voltage gets low. When the motor power decreases and the red LED on the ESC flashes, land the aircraft immediately and recharge the flight battery.

LVC does not prevent the battery from over-discharge during storage.

NOTICE: Repeated flying to LVC will damage the battery.

Landing

To land, slowly decrease the throttle while in a low-level hover. After landing, disconnect and remove the battery from the aircraft after use to prevent trickle discharge. Fully charge your battery before storing it. During storage, make sure the battery charge does not fall below 3V per cell.

Post-Flight Inspection and Maintenance Checklist

✓		
Ball Links		Make sure the plastic ball link holds the control ball, but is not tight (binding) on the ball. When a link is too loose on the ball, it can separate from the ball during flight and cause a crash. Replace worn ball links before they fail.
Cleaning		Make sure the battery is not connected before cleaning. Remove dust and debris with a soft brush or a dry, lint-free cloth.
Bearings		Replace bearings when they become notchy (sticky in places when turning) or draggy.
Wiring		Make sure the wiring does not contact moving parts. Replace damaged wiring and loose connectors.
Fasteners		Make sure there are no loose screws, other fasteners or connectors. Do not over-tighten metal screws in plastic parts. Tighten screws so the parts are mated together, then turn the screw only 1/8th of a turn more.
Rotors		Make sure there is no damage to rotor blades and other parts which move at high speed. Damage to these parts includes cracks, burrs, chips or scratches. Replace damaged parts before flying. Verify both main rotor blades have the correct and equal tension in the blade grips. When the helicopter is held up sideways, the main blades should support their own weight. When the helicopter is shaken lightly, the blades should fall.
Tail		Inspect the tail rotor for damage and replace if necessary. Verify the boom support bolts are tight and the plastic ends adhere to the carbon support rods. Verify the tail motor bolts, tail rotor adapter bolts and tail motor mount bolts are properly tightened. Inspect the tail boom for any damage and replace if necessary.
Mechanics		Inspect the main frame and landing gear for damage and replace if necessary. Check the mainshaft for vertical play and adjust the locking collar if necessary. Verify that the main gear mesh is correct and that no tight spots exist in the 360 degree rotation. Inspect all wires for damage and replace as necessary.

After a crash, for parts replacement or for more advanced setup and settings, go to the product page on www.horizonhobby.com <<http://www.horizonhobby.com>> and download the Blade 200 SR X Advanced Setup and Settings Guide.

Troubleshooting Guide

Problem	Possible Cause	Solution
Helicopter control response is inconsistent or requires extra trim to neutralize movement	Aircraft was not initialized properly or a vibration is interfering with the sensor operation	Disconnect the flight battery, center the control trim and re-initialize the helicopter
Helicopter will not respond to throttle	Throttle too high and/or throttle trim is too high	Disconnect the flight battery, place the throttle stick in the lowest position and lower the throttle trim a few clicks. Connect the flight battery and allow the model to initialize
	Helicopter moved during initialization	Disconnect the flight battery and re-initialize the helicopter while keeping the helicopter from moving
Helicopter has reduced flight time or is underpowered	Flight battery charge is low	Completely recharge the flight battery
	Flight battery is damaged	Replace the flight battery and follow the flight battery instructions
	Flight conditions might be too cold	Make sure the battery is warm (room temperature) before use
LED on receiver flashes rapidly and aircraft will not respond to transmitter (during binding)	Transmitter too near aircraft during binding process	Power off the transmitter. Move the transmitter a larger distance from the aircraft. Disconnect and reconnect the flight battery to the aircraft. Follow the binding instructions
	Bind switch or button was not held while transmitter was powered on	Power off transmitter and repeat bind process
	Aircraft or transmitter is too close to large metal object, wireless source or another transmitter	Move aircraft and transmitter to another location and attempt binding again
LED on the receiver flashes rapidly and the helicopter will not respond to the transmitter (after binding)	Less than a 5-second wait between first powering on the transmitter and connecting the flight battery to the helicopter	Leave the transmitter powered on. Disconnect and reconnect the flight battery to the helicopter
	The helicopter is bound to a different model memory (ModelMatch™ transmitters only)	Select the correct model memory on the transmitter. Disconnect and reconnect the flight battery to the helicopter
	Flight battery or transmitter battery charge is too low	Replace or recharge batteries
	Aircraft or transmitter is too close to large metal object, wireless source or another transmitter	Move aircraft and transmitter to another location and attempt connecting again
Helicopter vibrates or shakes in flight	Damaged rotor blades, spindle or blade grips	Check main rotor blades and blade grips for cracks or chips. Replace damaged parts. Replace bent spindle
Random movements in flight	Vibration	Verify the receiver is properly attached to the helicopter. Inspect mounting tape for damage. Verify that no wires are contacting the receiver. Inspect and balance all rotating components. Verify the main shaft and tail rotor adapter are not damaged or bent. Inspect mechanics for broken or damaged parts and replace as necessary
Tail oscillation/wag or poor performance	Loose boom supports, damaged tail rotor, main gear mesh, loose bolts, vibration	Verify that the boom support bolts are tight and the plastic boom support ends are properly adhered to the boom support rods. Inspect the tail rotor for damage. Verify that all bolts on the tail assembly are properly tightened. Verify main gear mesh and ensure no tight spots in the mesh through full rotation. Replace any damaged or worn components

Problem	Possible Cause	Solution
Drift in calm winds	Vibration, damaged linkage, damaged servo	Under normal operation the transmitter trims should not require adjustment and the center positions are memorized during initialization. If you find that trim adjustments are necessary after take off, verify the balance of all rotating components, ensure the linkages are not damaged and make sure the servos are in proper working condition.
Drift in wind	Normal	The model will drift with the wind but should remain level in flight. Simply hold the cyclic stick in the necessary position to keep the model stationary. The model must lean into the wind to remain stationary, if the model remains level then it will drift with the wind.
Panic Recovery or Return to Level does not level the model	Model was not initialized on a level still surface	Re-initialize the model on a level and still surface.
	Model was not taken off of a level surface	Always lift off from a level surface.
Severe vibration	Rotating component out of balance	Check the main shaft, tail rotor, main rotor blades, main frame and adapter for damage, replace as necessary. Vibration must be minimized for Panic Recovery and Return to Level functions to work properly.

Exploded View

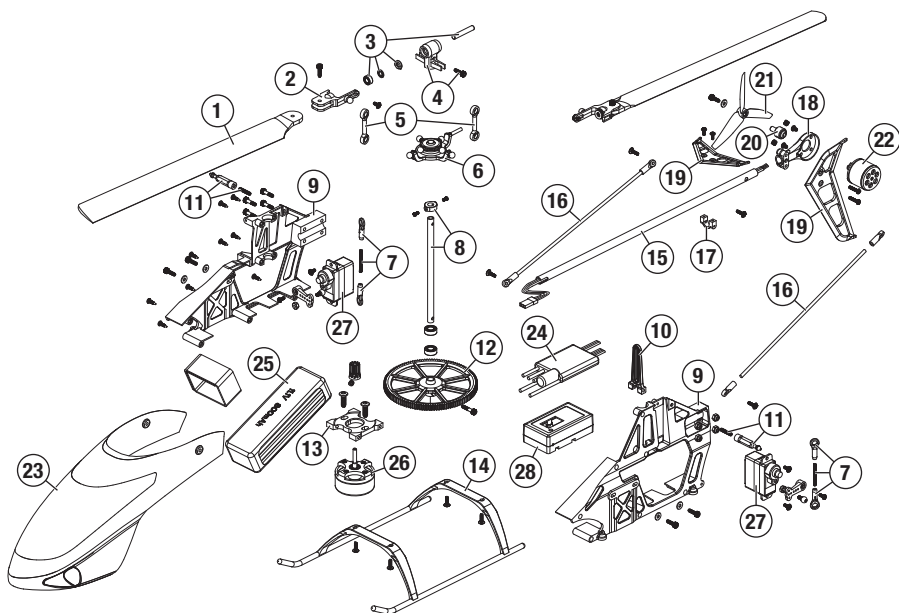

Parts Listings

Part #	Description
	BLH2000 200 SR X RTF
	BLH2080 200 SR X BNF
1	BLH2001 Main Blade Set (2), Wht: 200SRX
2	BLH2002 Main Blade Grips w/ Hdwe: 200SR
3	BLH2003 Spindle Set: 200SRX
4	BLH2004 Main Rotor Hub w/ Hdwe: 200SRX
5	BLH2005 Rotor Head Linkage St(4): 200SR
6	BLH2006 Swashplate: 200SRX
7	BLH2007 Pushrod Set (2): 200SRX
8	BLH2008 Main Shaft w/ Collar: 200SRX
9	BLH2009 Main Frame Set: 200SRX
10	BLH2010 Antirotation Bracket: 200SRX
11	BLH2011 Canopy Mount Set (2): 200SRX
12	BLH2012 Main Gear w/ Hdwe (2): 200SRX
13	BLH2013 Aluminum Motor Mount Set: 200SR
14	BLH2014 Landing Gear w/Hdwe, Wht: 200SR
15	BLH2015 Tail Boom w/ Motor Wires: 200SRX
16	BLH2016 Tail Boom Support Set (2): 200SRX
17	BLH2017 Horizontal Stab/Fin Mnt: 200SRX

Part #	Description
18	BLH2018 Tail Case: 200SRX
19	BLH2019 Stab Fin Set, White: 200SRX
20	BLH2020 Tail Rotor Hub Set: 200SRX
21	BLH2021 T/R Blade Set (2), Wht: 200SRX
22	BLH2022 Tail Motor: 200SRX
23	BLH2023 Canopy: 200SRX
24	BLH2024 Heli Dual Brushless ESC: 200SRX
25	EFLB8003SJ30 800mAh 3S 11.1V 30C LiPo, 18AWG JST
26	EFLH1516 3900Kv Brushless Motor: BSR
27	EFLRS60 6.0-Gram Super Sub-Micro S60 Servo
28	SPMAR636H AR636H SAFE Helicopter Receiver
	BLH2025 Main Blade Holder: 200SRX
	BLH2026 Complete Hdwe Set: 200SRX
	BLH2027 Tool Kit: 200SRX
	BLH2028 LP6DSM SAFE TX: 200SRX
	BLH20281 LP6DSM Mode 1 SAFE TX: 200SRX
	EFLC3105 3-Cell LiPo Balancing Charger, 0.8A
	EFLC4000 AC to 12VDC, 1.5-Amp Power Supply

Limited Warranty

What this Warranty Covers

Horizon Hobby, LLC, (Horizon) warrants to the original purchaser that the product purchased (the "Product") will be free from defects in materials and workmanship at the date of purchase.

What is Not Covered

This warranty is not transferable and does not cover (i) cosmetic damage, (ii) damage due to acts of God, accident, misuse, abuse, negligence, commercial use, or due to improper use, installation, operation or maintenance, (iii) modification of or to any part of the Product, (iv) attempted service by anyone other than a Horizon Hobby authorized service center, (v) Product not purchased from an authorized Horizon dealer, or (vi) Product not compliant with applicable technical regulations.

OTHER THAN THE EXPRESS WARRANTY ABOVE, HORIZON MAKES NO OTHER WARRANTY OR REPRESENTATION, AND HEREBY DISCLAIMS ANY AND ALL IMPLIED WARRANTIES, INCLUDING, WITHOUT LIMITATION, THE IMPLIED WARRANTIES OF NON-INFRINGEMENT, MERCHANTABILITY AND FITNESS FOR A PARTICULAR PURPOSE. THE PURCHASER ACKNOWLEDGES THAT THEY ALONE HAVE DETERMINED THAT THE PRODUCT WILL SUITABLY MEET THE REQUIREMENTS OF THE PURCHASER'S INTENDED USE.

Purchaser's Remedy

Horizon's sole obligation and purchaser's sole and exclusive remedy shall be that Horizon will, at its option, either (i) service, or (ii) replace, any Product determined by Horizon to be defective. Horizon reserves the right to inspect any and all Product(s) involved in a warranty claim. Service or replacement decisions are at the sole discretion of Horizon. Proof of purchase is required for all warranty claims. SERVICE OR REPLACEMENT AS PROVIDED UNDER THIS WARRANTY IS THE PURCHASER'S SOLE AND EXCLUSIVE REMEDY.

Limitation of Liability

HORIZON SHALL NOT BE LIABLE FOR SPECIAL, INDIRECT, INCIDENTAL OR CONSEQUENTIAL DAMAGES, LOSS OF PROFITS OR PRODUCTION OR COMMERCIAL LOSS IN ANY WAY, REGARDLESS OF WHETHER SUCH CLAIM IS BASED IN CONTRACT, WARRANTY, TORT, NEGLIGENCE, STRICT LIABILITY OR ANY OTHER THEORY OF LIABILITY, EVEN IF HORIZON HAS BEEN ADVISED OF THE POSSIBILITY OF SUCH DAMAGES. Further, in no event shall the liability of Horizon exceed the individual price of the Product on which liability is asserted. As Horizon has no control over use, setup, final assembly, modification or misuse, no liability shall be assumed nor accepted for any resulting damage or injury. By the act of use, setup or assembly, the user accepts all resulting liability. If you as the purchaser or user are not prepared to accept the liability associated with the use of the Product, purchaser is advised to return the Product immediately in new and unused condition to the place of purchase.

Law

These terms are governed by Illinois law (without regard to conflict of law principals). This warranty gives you specific legal rights, and you may also have other rights which vary from state to state. Horizon reserves the right to change or modify this warranty at any time without notice.

WARRANTY SERVICES

Questions, Assistance, and Services

Your local hobby store and/or place of purchase cannot provide warranty support or service. Once assembly, setup or use of the Product has been started, you must contact your local distributor or Horizon directly. This will enable Horizon to better answer your questions and service you in the event that you may need any assistance. For questions or assistance, please visit our website at www.horizonhobby.com, submit a Product Support Inquiry, or call the toll free telephone number referenced in the Warranty and Service Contact Information section to speak with a Product Support representative.

Inspection or Services

If this Product needs to be inspected or serviced and is compliant in the country you live and use the Product in, please use the Horizon Online Service Request submission process found on our website or call Horizon to obtain a Return Merchandise Authorization (RMA) number. Pack the Product securely using a shipping carton. Please note that original boxes may be included, but are not designed to withstand the rigors of shipping without additional protection. Ship via a carrier that provides tracking and insurance for lost or damaged parcels, as Horizon is not responsible for merchandise until it arrives and is accepted at our facility. An Online Service Request is available at http://www.horizonhobby.com/content/_service-center_render-service-center. If you do not have internet access, please contact Horizon Product Support to obtain a RMA number along with instructions for submitting your product for service. When calling Horizon, you will be asked to provide your complete name, street address, email address and phone number where you can be reached during business hours. When sending product into Horizon, please include your RMA number, a list of the included items, and a brief summary of the problem. A copy of your original sales receipt must be included for warranty consideration. Be sure your name, address, and RMA number are clearly written on the outside of the shipping carton.

NOTICE: Do not ship LiPo batteries to Horizon. If you have any issue with a LiPo battery, please contact the appropriate Horizon Product Support office.

Warranty Requirements

For Warranty consideration, you must include your original sales receipt verifying the proof-of-purchase date.

Provided warranty conditions have been met, your Product will be serviced or replaced free of charge. Service or replacement decisions are at the sole discretion of Horizon.

Non-Warranty Service

Should your service not be covered by warranty, service will be completed and payment will be required without notification or estimate of the expense unless the expense exceeds 50% of the retail purchase cost.

By submitting the item for service you are agreeing to payment of the service without notification. Service estimates are available upon request. You must include this request with your item submitted for service. Non-warranty service estimates will be billed a minimum of ½ hour of labor. In addition you will be billed for return freight. Horizon accepts money orders and cashier's checks, as well as Visa, MasterCard, American Express, and Discover cards. By submitting any item to Horizon for service, you are agreeing to Horizon's Terms and Conditions found on our website http://www.horizonhobby.com/content/_service-center_render-service-center.

ATTENTION: Horizon service is limited to Product compliant in the country of use and ownership. If received, a non-compliant Product will not be serviced. Further, the sender will be responsible for arranging return shipment of the un-serviced Product, through a carrier of the sender's choice and at the sender's expense. Horizon will hold non-compliant Product for a period of 60 days from notification, after which it will be discarded.

Warranty and Service Contact Information

Country of Purchase	Horizon Hobby	Contact Information	Address
United States of America	Horizon Service Center (Repairs and Repair Requests)	servicecenter.horizonhobby.com/RequestForm/	4105 Fieldstone Rd Champaign, Illinois, 61822 USA
	Horizon Product Support (Product Technical Assistance)	www.quickbase.com/db/bghj7ey8c?a=GenNewRecord 888-959-2304	
	Sales	sales@horizonhobby.com 888-959-2304	
United Kingdom	Service/Parts/Sales: Horizon Hobby Limited	sales@horizonhobby.co.uk	Units 1-4 , Ployters Rd, Staple Tye Harlow, Essex, CM18 7NS, United Kingdom
		+44 (0) 1279 641 097	
Germany	Horizon Technischer Service Sales: Horizon Hobby GmbH	service@horizonhobby.de	Christian-Junge-Straße 1 25337 Elmshorn, Germany
		+49 (0) 4121 2655 100	
France	Service/Parts/Sales: Horizon Hobby SAS	infofrance@horizonhobby.com	11 Rue Georges Charpak 77127 Lieusaint, France
		+33 (0) 1 60 18 34 90	
China	Service/Parts/Sales: Horizon Hobby – China	info@horizonhobby.com.cn	Room 506, No. 97 Changshou Rd. Shanghai, China 200060
		+86 (021) 5180 9868	

FCC Information

This device complies with part 15 of the FCC rules. Operation is subject to the following two conditions: (1) This device may not cause harmful interference, and (2) this device must accept any interference received, including interference that may cause undesired operation.



CAUTION: Changes or modifications not expressly approved by the party responsible for compliance could void the user's authority to operate the equipment.

This product contains a radio transmitter with wireless technology which has been tested and found to be compliant with the applicable regulations governing a radio transmitter in the 2.400GHz to 2.4835GHz frequency range.

IC Information

This device complies with Industry Canada license-exempt RSS standard(s). Operation is subject to the following two conditions:

(1) this device may not cause interference, and (2) this device must accept any interference, including interference that may cause undesired operation of the device.

Compliance Information for the European Union

Declaration of Conformity

(in accordance with ISO/IEC 17050-1)

No. HH2014041103

Product(s): Blade 200 SR X BNF
Item Number(s): BLH2080EU/BLH2080UK
Equipment class: 1

The object of declaration described above is in conformity with the requirements of the specifications listed below, following the provisions of the European R&TTE directive 1999/5/EC, EMC Directive 2004/108/EC and LVD Directive 2006/95/EC:

EN 301 489-1 V1.9.2: 2012

EN 301 489-17 V2.1.1: 2009

EN61000-3-2:2006+A1:2009+A2:2009

EN61000-3-3:2008

EN60950-1:2006+A11:2009+A1:2010+A12: 2011

EN55022:2010 + AC:2011

EN55024:2010



Signed for and on behalf of:
Horizon Hobby, LLC.
Champaign, IL USA
Apr 11, 2014

Robert Peak
Chief Financial Officer
Horizon Hobby, LLC

Declaration of Conformity

(in accordance with ISO/IEC 17050-1)

No. HH2014041102

Product(s): Blade 200 SR X RTF
Item Number(s): BLH2000EU1/BLH2000EU2/
BLH2000UK1/BLH2000UK2
Equipment class: 1

The object of declaration described above is in conformity with the requirements of the specifications listed below, following the provisions of the European R&TTE Directive 1999/5/EC, EMC Directive 2004/108/EC and LVD Directive 2006/95/EC:

EN 300-328 V1.7.1: 2006

EN 301 489-1 V1.9.2: 2012

EN 301 489-17 V2.1.1: 2009

EN60950-1:2006+A11:2009+A1:2010+A12: 2011

EN61000-3-2:2006+A1:2009+A2:2009

EN61000-3-3:2008

EN55022:2010 + AC:2011

EN55024:2010



Signed for and on behalf of:
Horizon Hobby, LLC
Champaign, IL USA
Apr 11, 2014

Robert Peak
Chief Financial Officer
Horizon Hobby, LLC

Instructions for disposal of WEEE by users in the European Union



This product must not be disposed of with other waste. Instead, it is the user's responsibility to dispose of their waste equipment by handing it over to a designated collection point for the recycling of waste electrical and electronic equipment. The separate collection and recycling of your waste equipment at the time of disposal will help to conserve natural resources and make sure that it is recycled in a manner that protects human health and the environment. For more information about where you can drop off your waste equipment for recycling, please contact your local city office, your household waste disposal service or where you purchased the product.

©2014 Horizon Hobby, LLC.

Blade, E-flite, SAFE, the SAFE logo, DSM, DSM2, DSMX, the BNF logo, ModelMatch and the Horizon Hobby logo are trademarks or registered trademarks of Horizon Hobby, LLC.

The Spektrum trademark is used with permission of Bachmann Industries, Inc. Futaba is a registered trademark of Futaba Denshi Kogyo Kabushiki Kaisha Corporation of Japan. All other trademarks, service marks or logos are property of their respective owners.
Patents pending. Created 11/13 40394 BLH2000, BLH2080